



TECHNICAL PARAMETERS



Nominal capacity, m ³ /h (l/min)	30 (500)
Ultimate vacuum, mbar abs.	5x10 ⁻³
Inlet / Outlet connection	DN 40 KF
Gearbox oil volume, l	1,9
Rotation speed, rpm	1450
Frequency, Hz	50
Motor power, kW	1,1
Sound pressure level, dB(A)	63
Total weight, kg	43

- two-stage with oil-lubrication
- with air cooling
- with integrated check valve and gas ballast valve

RVLD two-stage rotary vane pumps with oil-lubrication are designed for efficient pumping, simple operation and easy maintenance. The pump body is made in aluminum, connecting KF-flanges are made in stainless steel. The pump has a integrated check valve and a gas ballast to set the limit of the maximum residual pressure (vacuum operating range).

RVLD vacuum pumps have a very wide application: in research and high-tech industries, for example, in the semiconductor industry, in the production of electronic devices, measuring instruments, light bulbs, in neon factories, in freeze drying, distillation, mass spectrometry. RVLD two-stage oil-lubricated pumps are also often used as a backing pump in high-vacuum units.

PUMPING SPEED

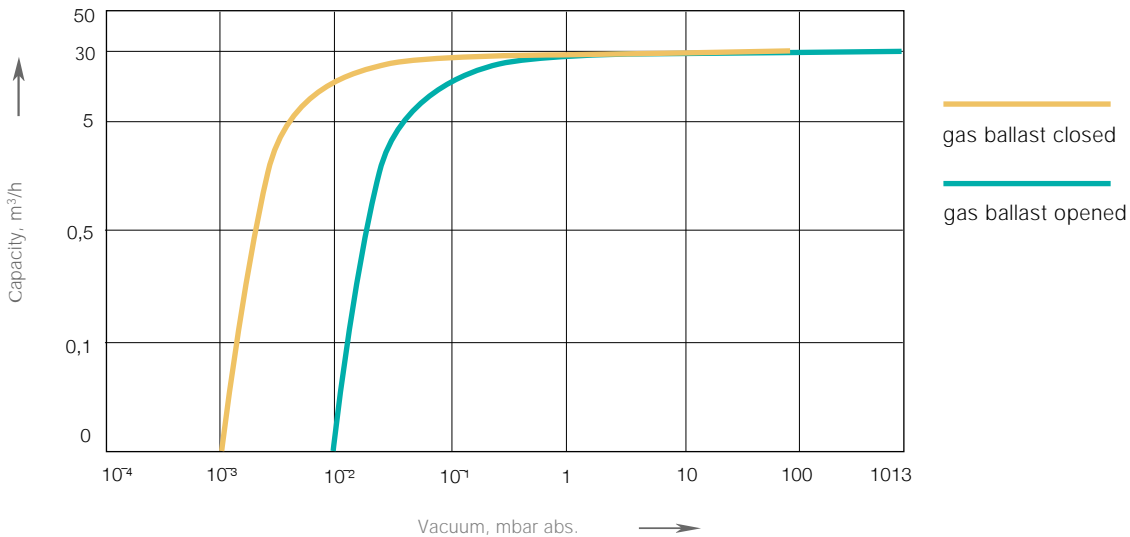

The given data are referred to dry air at the temperature of 20°C, at the atmospheric discharge pressure (1013 mbar). Performances tolerance ±10%.



The gas ballast valve has two positions: closed, open. The pump is self-cleaning and removes condensed gases from the oil by supplying fresh air to the second cylinder of the pump to prevent mist condensation.

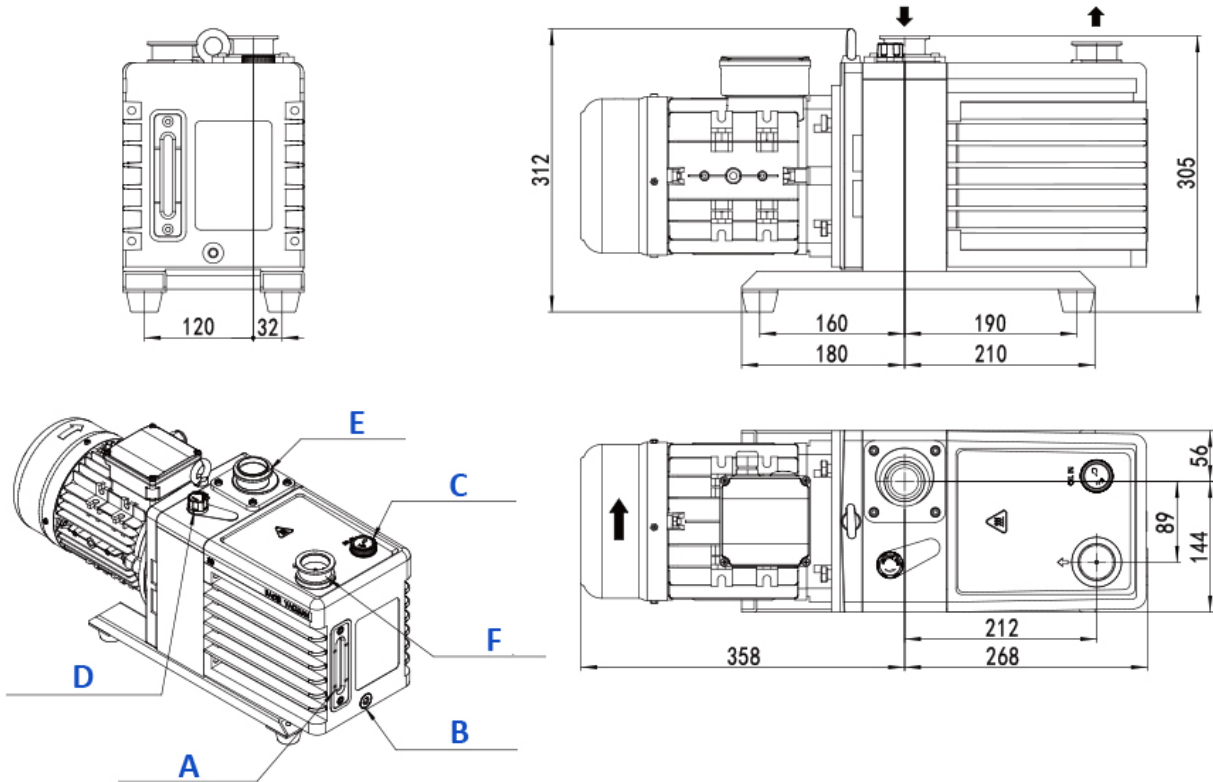

All dimensions in the drawings are indicated in mm

A	B	C	D	E	F
Oil level sight glass	Drainage G 3/8"	Oil filling hole G 3/4"	Gas ballast switch	Inlet DN 40 KF	Outlet DN 40 KF

OIL MIST FILTER TMF-36

To reduce air pulsations at the pump outlet, and also to ensure a clean working space, available as an additional option install oil mist filter TMF-36 (capacity 36 m³/hour).

Double filtration system captures oil vapors returns the collected oil to the pump and protects from possible oil leaks.

A	B	C	D	E
Ø120	60	Ø40	83	166
F	G	H	I	
Ø40	4-M8	Outlet DN 25 KF	Outlet DN 25 KF	

